

... more precise, more robust, more safe.

New All Sky Imaging Solutions

2024/03 - New Options - New Features - As Perfect As Ever



Dual-S/FTP support (mirror, fallback)
High-precision external T/RH Sensor
Fast 1-second Pyranometer data logging
HDR 5MP outdoor qualified imager head
180/360° fisheye lens, coated quartz dome

Safe data file transfer protocols (FTPS, SFTP)
Fast image shooting intervals (10/15/20 sec)
Temp -40°C to $+80^{\circ}\text{C}$, Ventilation, Heating
Data Logger - Hardware and Software
OPTION: Pyranometer Interface

ASI-16/55 Hardware - Components - Options - Models



Simple Mount

External sensor without optional Radiation Shield.

ASI-16/55 - Advanced (mod 2024/03)

Forced Ventilation and up to 60W Airflow Heating
 CMS-HPoE Power Supply, 80W, 48VDC, 110/240VAC
 External Precision Sensor, Temperature and Humidity
 Integrated Data Logger (Hardware & Software)

./55 Options (not included):

Pyranometer Modbus Interface
 Pyranometer Mounting Arm
 T/RH Sensor Radiation Shield
 Enhanced Protection T/RH Sensor

Pyranometer Modbus Interface: Available as option, implementation via software update.

Note: Digital sensors require vendor-specific protocols. Today's firmware supports EKO-brand protocol. Other protocols will be added subject to demand and vendor technical support.

Hardware Maintenance: The fully modular mechanical and electrical design, and just 3 screws to access the interior ensures most easy maintenance and allows later optional upgrades.

Pyranometer Mounting Arm:

To mount a Pyranometer directly to an ASI-16.
 Flexible adjustments for GHI or GTI setups.



Allows very easy mounting of one Pyrano to an ASI-16 body without special additional (mechanical) tools and components.

ASI-16/15 - BASIC :

Lower-cost ASI-16 model, limited functions.
 NOT recommended for harsh environments.



VERY IMPORTANT:
 Request and check deviating functions, specs and limits of use and operation.
 NOT recommended for hot/cold/harsh/ and/or remote sites.

ASI-16/nn Software - User Interface - Data Storage

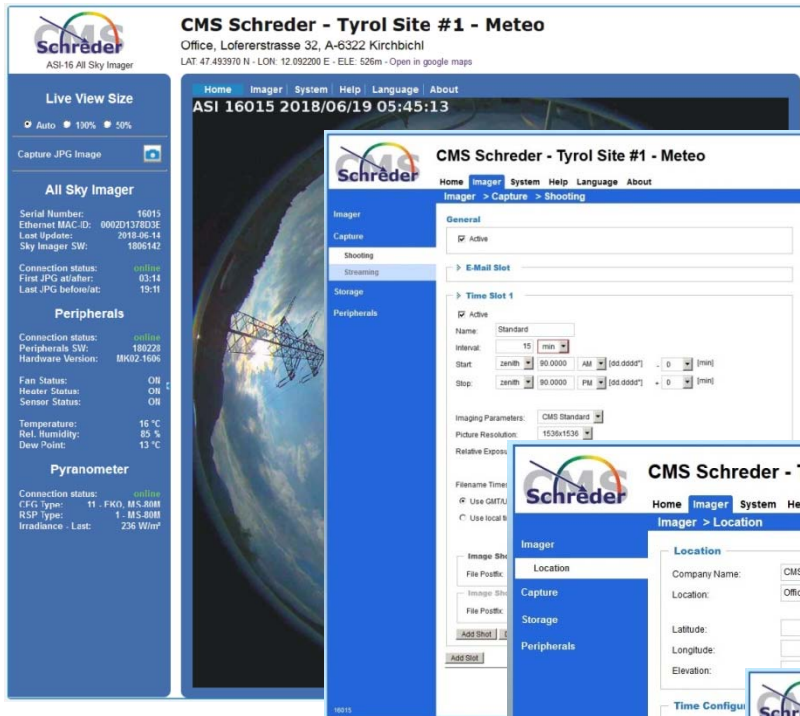

Web-browser based user interface.
Settings & monitoring via Web-GUI.
Online / offline software updating.
Secured settings on CMS servers.

Advanced shooting scheduler.
Zenith-angle- and time-controlled.
Multiple pictures per time slot.
Multiple exposures per slot.
Multiple sets of time slots.
Timestamps: UTC or Local Time.

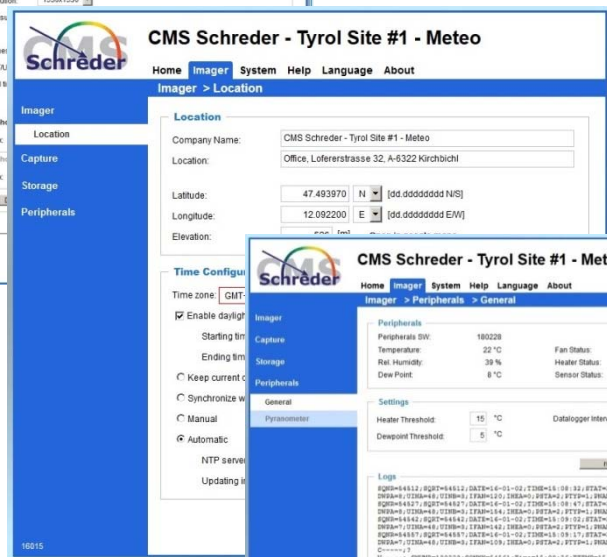

Client Site Location (Lat/Lon/Ele),
stored into each JPG EXIF dataset.
JPGs upload to (S)/FTP(S) storage.
Temporary local storage in case
of FTP server or network problems.
JAVA-based maintenance tools.

Auto-created file server directories (./ASI- SN/Date/).
Prepared also for future CMS cloud analysis software.
Multiple remote access options (HTTPS, DDNS, VPN).

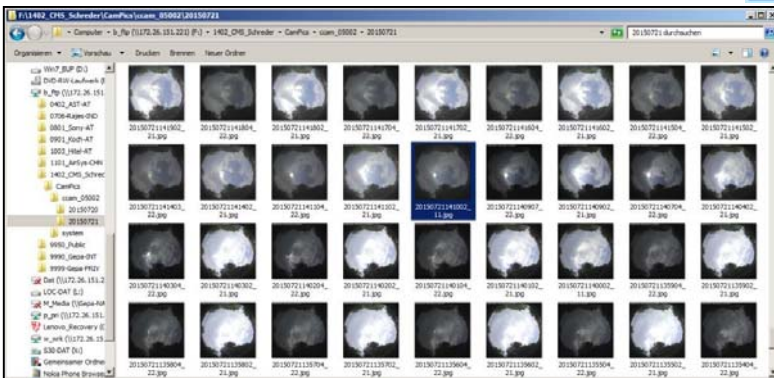
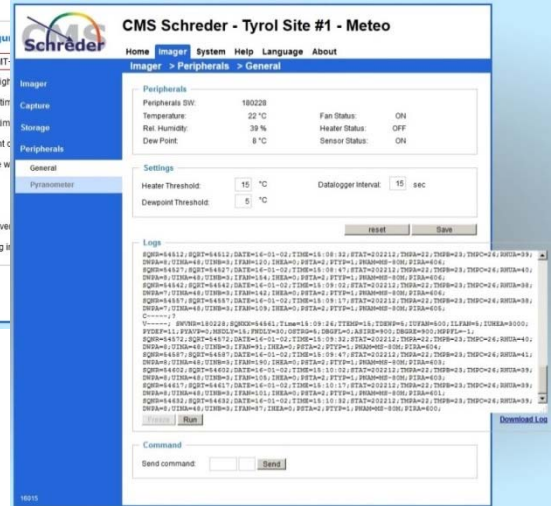

Above: Data Logger Screen.
See life data , set parameters.
Sensor and system data also
stored into JPG EXIF dataset.
Available on ASI-16/5n only.

Left: Series of pictures with
variations in exposure level,
stored onto (S)FTP(S) server.

CMS ASI-16 System, General Data, applicable for BOTH ASI-16/5n_Advanced and ASI-16/1n_Basic			
Imaging Sensor Chip	1/1.8" Progressive CMOS	LAN Network Type	100 BaseTX Ethernet (RJ-45) - IPv4, IPv6, TCP/IP, HTTP, (HTTPS), FTP, FTPS, SFTP, DHCP, NTP, DNS, DDNS, RTSP/ RTCP, SMTP, PPPoE, SNMP, SSL,
Imaging Sensor Resolution	3096 x 2094, 5 Megapixel	Network Protocols	
Useable Resolution	1920x1920 (Fisheye)		
Field of View (useable View)	180° / 360° (150° / 360°)		
Lens, Focal Length, Aperture	Fixed-focal, f=1.47mm, F2.2		
Optical Dome	Strong Quartz Glass, coated	Software Updater, Tools	Management software, Java
Imager Spectral Range	Visible Spectrum	Data file network upload	S/FTP/S server (file server)
Minimal Illumination	0.18 Lux @ F2.2 (Color)	Realtime life stream	MJPEG, H.265, H.264
WDR Techn., Dynamic Range	WDR PRO (Enh.), 100 dB	Graphic User Interface	Web Browser, WIN-7/.../10
Ventilation, heating (. /5n only)	80 m3/h, 60W heating power	Power supply system	HPoE (Power over Ethernet)
Environmental Sensor (. /5n only)	Temp/RH, Sensirion SHT85	Power supply input	CMS-HPoE, 100V - 240V AC
Pyranometer Interface (. /5n only)	digital, ModBus (RS-485)	Power consumption	. /5n: 15W/80W; . /1n: 15W;
Internal data backup memory	Industrial MicroSD CF, 4GB	Operating temperature	-40°C (-25°C) to +80°C (limited)
Mounting rod dimensions:	DM: 37mm to 40mm (max)	Environmental Protection	IP66, EN50155,

FCT-22_DB FindClouds Trinity - Cloud Analysis Software

WIN-based SW to analyze ASI-16 images. - Evaluation Data are stored in User SQL Database.
 Not part of ASI-16 scope of delivery. - Please request specific detailed documents.

FCB Cloud Detection / Coverage

Detection of clouds as "Cloud Objects".
 Therefrom generate "false colour" images.
 Calculate numeric "Cloud Coverage Ratio".

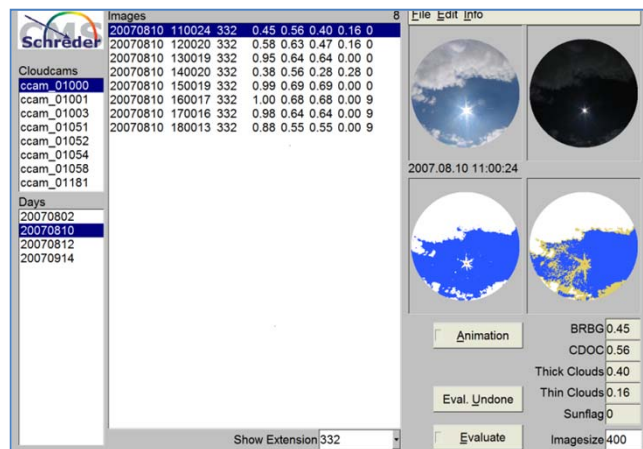
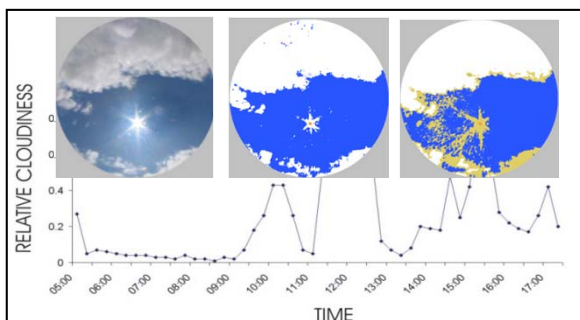

CMV Cloud Motion (optional)

"Average Cloud Motion Vector" (direction, virtual speed in pixel/sec) is calculated by comparing two immediately (about 15-30 seconds delay) consecutive ASI images.

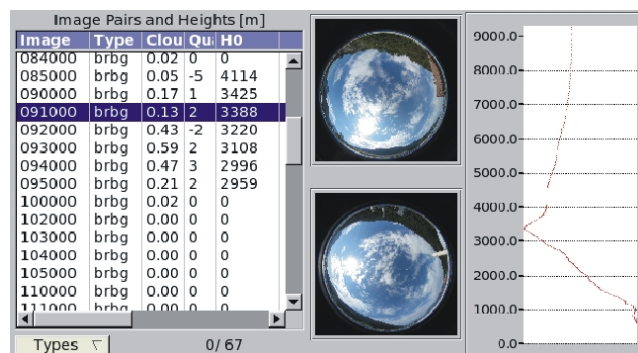

CBH Cloud Base Height (optional)

"Average Cloud Base Height" is calculated by using stereoscopic algorithms, combining two (2) time synchronized images from two (2) ASI-16 imagers mounted at a distance about 1500m.

ASI-16 V24 Sky Imager Versions - Quick Compare	
For detailed comparisons of all features and functions, please check the "Full-Compare" page.	
ASI-16/55 ADVANCED	ASI-16/15 BASIC
	
Includes outer shield protection cover.	IP65 outdoor protected imager head.
Forced air flow through fan ventilation.	Without airflow fan ventilation.
Heated forced air flow (fan and heater)	Without heated forced air flow.
Ready for very hot/cold/harsh environments.	Limited used in very harsch environments
Including high precision Temp/RH sensors.	Without any environmental data nsensors.
Optional digital interface for Pyranometer.	Not available.
Integrated data logger for sensor data.	Not available.
Prepared for later hardware upgrades.	Not available.

"ASI-16/5n V24 ADVANCED" Sky Imager - Worldwide Unique Combined Feature Set.	
Features, Functions, Topics:	<i>Notice: Limited functions of "ASI-16/1n BASIC" are explained in "Compare-Tables".</i>
Operating temperature:	Better than -35°C to +70°C, below -35°C even as start-up temperature.
Outer shell protection	Protection against strong direct sun radiation, and against rain, snow and wind.
Glass dome ventilation	Strong and coated quartz glass dome, being cooled and/or heated by air ventilation.
Air flow heating power	Ventilation air heated with minimum 60W heating power, whenever needed.
Air flow heating control	Automatically, set by user defined parameters (Temperature, Humidity).
Image capturing scheduler	User defined flexible scheduler, for example one image set each 1/5/15/30 minutes.
Fast shooting for nowcast	Fast shooting intervals, 10/15/20/30 seconds, necessary for cloudiness nowcasting.
Sunrise sunset controls	User defined automated option to store images between sunrise and sunset only.
Environment sensors	Integrated high precision environment sensor for Temperature and Relative Humidity.
Solar irradiance sensor	Integrated interface for professional Pyranometer (ISO 9060/2018, Class A, spectraly flat).
Data logger functions	Sensor data stored in a datalogger csv file, and in the EXIF data set of each JPG image.
Data communication	Ethernet (TCP/IP), LAN (Local Area Network).
Real time user interface	Web browser based GUI (Graphical User Unterface), via HTTP.
Life image video stream	Web GUI shows a life image video stream, 1 image/second or faster.
Image and data storage	To network based file server, via (S/)FTP protocol. Dual-FTP support (mirror, fallback).
Internal data backup memory	Internal emergency backup memory for more than 8000 JPG images and sensor data.
Power supply technology	Power over Ethernert (CMS HPoE), data and up to 80W power within one single cable.
Hardware service, repairs	User can service and exchange key components on site, without special tools.

CMS-ASI-16, Special Descriptions, Functions	ASI-16/5n Adv.	ASI-16/1n Basic
ASI-16 Management Software & Tools	identical, see "Info Sheet" and Manual	
Web browser based user interface (GUI)	identical, see "Info Sheet" and Manual	
Imaging scheduler, image storage manager	identical, see "Info Sheet" and Manual	
Internal data storage (Backup) if network down	identical, see "Info Sheet" and Manual	
Peripherals Controller - Management Site	YES	NO
Peripherals Controller - Data Logger Functions	YES	NO
Optical system, optical sensor, imaging head	identical, see "Technical Data"	
Network protocols, network functions	identical, see "Technical Data"	
Power supply technology	CMS-HPoE	Standard PoE
Power consumption, (with heating on)	25W (80W)	15W
Operating temperature (at start-up time)	-40°C to +80°C	-25°C - +50°C *)
Remark for /10: Strong sun irradiation limited.	YES	LIM
Dimensions: Outer Diameter	200 mm	180 mm
Dimensions: Height without (including) base	250/350mm	100/200 mm
Outer protection cover (outer hood)	YES	NO
- protection against strong direct sun radiation	YES	NO
- protection against heavy snow and rain	YES	NO
Peripherals Management Controller	YES	NO
- Sensors for temperature and humidity	YES	NO
- Heating control via Temp. and Dew Point	YES	NO
- Ready for High Precision TRH measurement	YES	NO
- System monitoring and fault alarms	YES	NO
- System and sensor "datalogger" functions	YES	NO
Optional Hardware Upgrades possible	YES	NO
- allow later upgrades for other sensors	YES	NO
- Pyranometer Modbus - Available as option	OPT	NO
Forced air flow through fan ventilation	YES	NO
- cooling in case of strong direct sun radiation	YES	NO
- support to keep the glass dome clean & dry	YES	NO
Heated forced air flow (fan and heater)	YES	NO
- heating in case of snow, ice and dew	YES	NO
- support to keep glassdome clean & dry	YES	NO

CMS ASI-16 V24 System, General Data, applicable for BOTH ASI-16/5n-Advanced and ASI-16/1n-Basic			
Imaging Sensor Chip	1/1.8" Progressive CMOS	LAN Network Type	100 BaseTX Ethernet (RJ-45) -
Imaging Sensor Resolution	3096x2094, 5 Megapixel	Network Protocols	IPv4, IPv6, TCP/IP, HTTP, (HTTPS), FTP, DHCP, NTP, DNS, DDNS, RTSP/ RTCP, SMTP, PPPoE, SNMP, SSL,
Useable Resolution	1920 x 1920 (Fisheye)		
Field of View (useable View)	180° / 360° (150° / 360°)		
Lens, Focal Length, Aperture	Fixed-focal, f=1.47mm, F2.2		
Optical Dome	Strong Quartz Glass, coated	Software Updater, Tools	Management software, Java
Imager Spectral Range	Visible Spectrum	Data file network upload	FTP server, file share server
Minimal Illumination	0.18 Lux @ F2.2 (Color)	Realtime life stream	MJPEG, H.265, H.264
WDR Techn., Dynamic Range	WDR PRO (Enh.), 100 dB	Graphic User Interface	Web Browser, WIN-7/.../10
Ventilation, heating (./51 only)	80 m3/h, 60W heating power	Power supply system	HPoE (Power over Ethernet)
Environmental Sensor (./51 only)	Temp/RH, Sensirion SHT75	Power supply input	CMS-HPoE, 100V - 240V AC
Pyranometer Interface (./51 only)	digital, ModBus (RS-485)	Power consumption	./5n: 15W/80W; ./1n: 15W;
Internal data backup memory	Industrial MicroSD CF, 4GB	Operating temperature	-40°C (-25°C) to +80°C (limited)

CMS ASI-16/5n ADVANCED

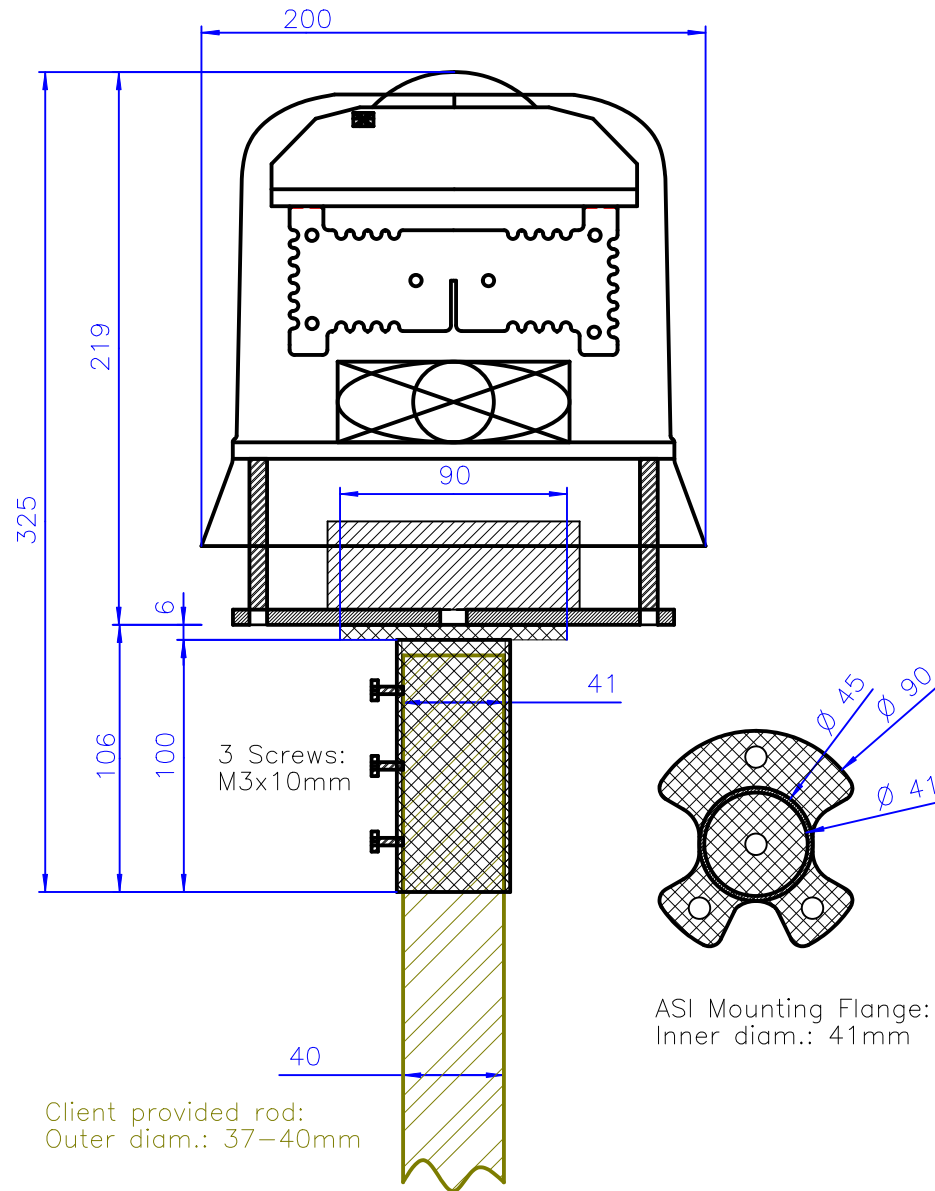

CMS ASI-16/1n BASIC

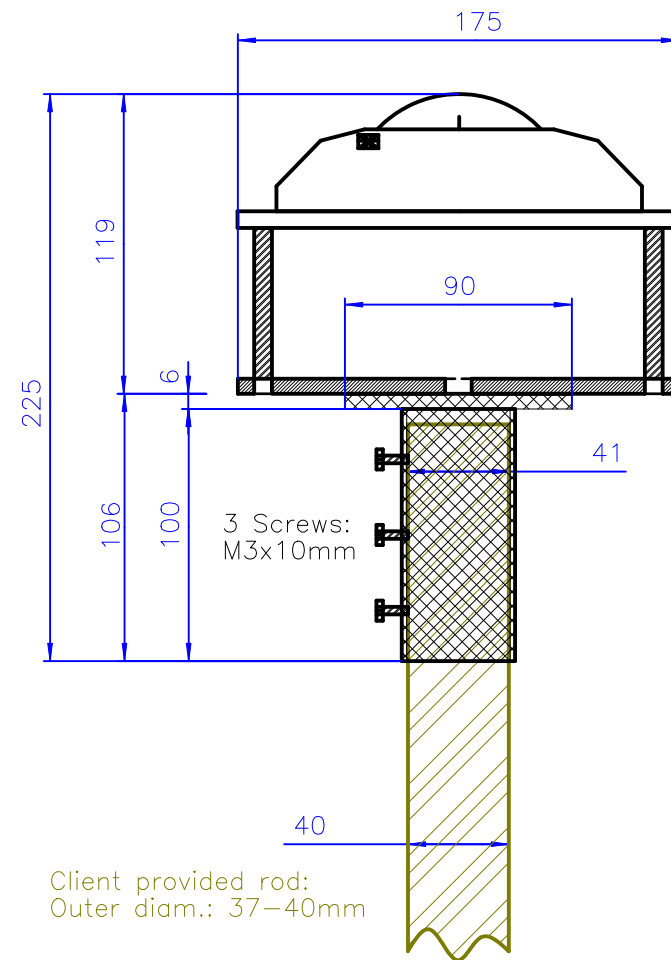

Pyranometer Modbus Option Pyranometer Mounting Arm External Temp/RH-Sensor



Pyranometer Option: To connect and operate a Modbus Pyranometer with any new ASI-16/5n, for logging of real-time irradiance data (Act, AvP, AvM, Min, Max). Subject to purchase of ASI Pyranometer Option. - Activation after Purchase.

Pyrano Mounting Arm: To mount a Pyranometer directly onto the ASI-16/5n base plate, avoiding any additional third-party mechanical mounting tools. - Allows mechanical sensor adjustments for qualified measurement of GHI or GTI.



ASI-16/5n All Sky Imagers - Options

Pyranometer Modbus Option - Introduction

CMS ASI-16/5n "Pyranometer Modbus Option" allows to connect selected types of Pyranometers (with digital Modbus output) directly to an ASI imager. (This option DOES NOT support Pyranometers with analogue-only output.)

Currently implemented vendor Modbus protocols:
EKO Instruments: MS-80M, MS-60M, MS-40M, ML-01M.

Other vendor's Modbus protocols: Not implemented, yet.
Maybe can be implemented upon request, likely at additional costs.
Implementation subject to clarification and tech support of vendor.

External High Precision Temperature/Humidity Sensor:

The new high-precision Temp/RH sensor (Sensirion SHT85) now comes with a cable and a stainless steel metal tube, ready to be mounted into a professional "Radiation Shield", to ensure high quality Meteo-standard Temp/RH data.

NOTICE: The Temp/RH sensor MUST be connected IN ANY CASE, as it is MANDATORY for operation and control of heating and ventilation functions.

Irradiance Data - Retrieval and Storage (in W/m²):

Internally, ASI PeriCon (Peripheral Controller) retrieves one value per second. Latest 1-second Irradiance data are stored into each JPG image, in the EXIF data set, and are recorded into ASI PeriCon "...PeriData-yymmdd.csv" datalogger files. Maximum logging speed can be configured up to 1 dataset per second.

ASI Software - Installation, Setup, Configuration

Upon purchase of the "Pyrano Option", please indicate the type of Pyrano. So, at activation, CMS can already pre-define the Pyrano type in CMS-CRM. If you did NOT indicate a Pyrano Type, then set it up in CMS-CRM yourself. We recommend to set the Pyrano-Type in CMS-CRM, before "FULL RESET" Of course, you also can set your Pyrano-Type later on, in the ASI-GUI. BUT, on later "FULL-RESET's", local ASI-GUI settings are reset to CMS-CRM.

ASI PeriCon Firmware Upgrade (for recently added new Pyrano vendors, only):
Requires a special UART/USB cable and software. - Please contact your agent.

Pyranometer Option - Hardware Delivery and Mounting



CMS ASI-16/5n "Pyranometer Mounting Arm" comes with two non-pre-assembled arm components, and small additional parts (screws, washers) for assembly and mounting. - Screws to mount the Pyranometer itself are NOT included. Usual those screws are a part of the Pyranometer supplier scope of supply.

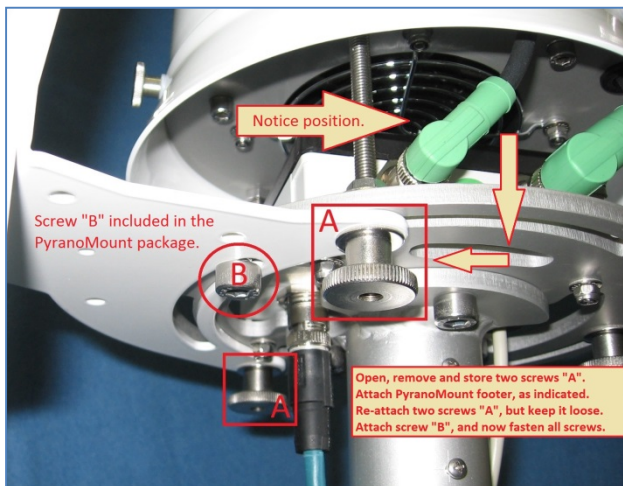

For proper mounting of the "Pyranometer Mounting Arm", follow instructions within the picture. - NOTICE: There are three possible ways of mounting. Only ONE ensures the correct North-South arm orientation, necessary for non 90° tilt angle adjustments, required for GTI.



When mounting the Pyranometer, consider Northern or Southern hemisphere. The plug and cable always shall face "away from sun", to avoid heat by exposure to direct sun radiation, therefore likely corrupt Pyrano irradiance data.

Pyranometer Option - Software Functions

ASI-16/5n "Pyranometer Option" is an OPTION, not part of standard delivery. It supports specified Pyranometer with a digital Modbus output interface, only.

To activate this option, you must purchase and pay the applicable option fee. After CMS-Schreder confirmation, you must run an ASI-Manager "FULL RESET". And, you must purchase and mount an ASI-compatible Modbus Pyranometer. At the moment, CMS ASI-16/5n supports EKO Modbus Pyranometers, only.

Pyranometer Option - Datalogger CSV-File - Irradiance Data

PIRA: Last Second Value "PIR_": Irradiance Values in [W/m²]
 PIRP: Packaged Average PIRM: Moving Average
 PIRH: Last Interval Maximum PIRL: Last Interval Minimum
 Average time period and PIRM weighting to be customized, via parameters.
 ASI Datalogger captures 1/sec raw values, and calculates others there from.

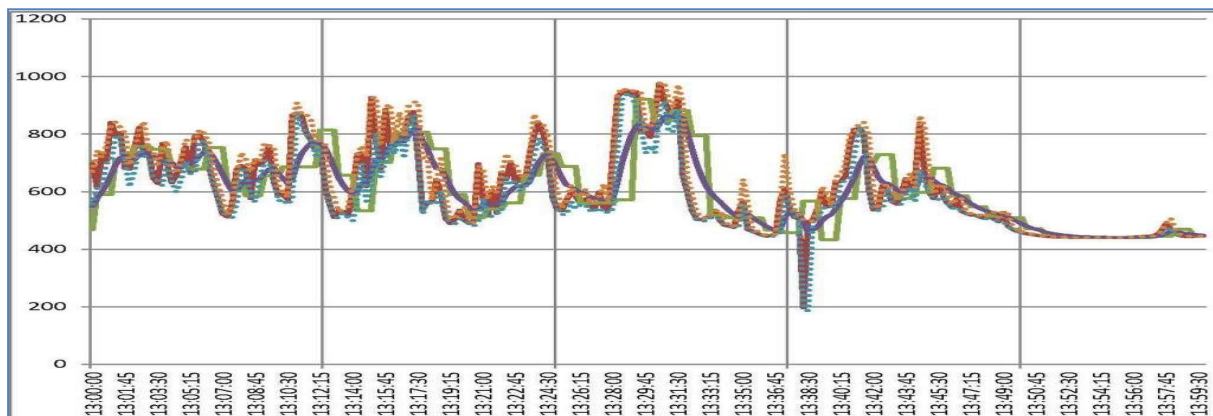
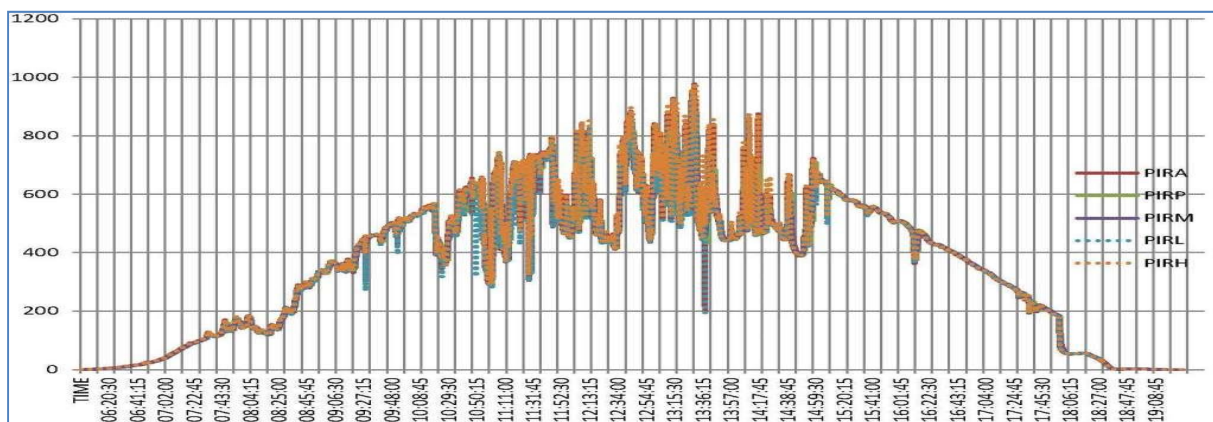

Specifications and designs in this paper are preliminary and for general information purpose, only.

Prüfbericht Test Certificate

Prüfgegenstand // Object:	Extreme Temperature stress test up to $T_{ENV} = +85.5^{\circ}\text{C}$ of an All Sky Imager ASI-16/5n.
Auftraggeber // Customer:	CMS Ing. Dr. Schreder GmbH Lofererstraße 32, A-6322 Kirnbichl AUSTRIA
Hersteller // Manufacturer:	CMS Ing. Dr. Schreder GmbH
Typ // Type:	ASI-16/5n
Seriennummer // Serial number:	16015
Datum // Date:	4. July 2020 - 16. July 2020
Seitenanzahl // Number of pages:	5
Ergebnis // Result:	The All Sky Imager was successfully tested for standard operation modus (1 image @ 5 minutes) under extreme temperature stress with an environment temperature up to $+85.5^{\circ}\text{C}$. The test was running for 12 days. The temperature sensor of the ASI has a typical tolerance of $\pm 0.25^{\circ}\text{C}$ @ $+85^{\circ}\text{C}$. The system was running under these test scenario without troubles without loss of image data.

Dieser Prüfschein darf nur vollständig und unverändert verbreitet werden. Auszüge oder Änderungen bedürfen der Genehmigung des Kalibrierlaboratoriums der Firma CMS Ing. Dr. Schreder GmbH. Dokumente ohne Unterschrift und Siegel haben keine Gültigkeit. // *This certificate shall not be reproduced other than in full expect with the permission of the calibration laboratory of the company CMS Ing. Dr. Schreder GmbH. Documents without signature and seal are not valid.*

Siegel // Seal

Ausstellungsdatum // Date

**Für den technischen Inhalt verantwortlich
//Responsible regarding technical content**

16. July 2020

Ing. Dr. Josef Schreder

Prüfgegenstand // Description of the calibration object:

Test of an All Sky Imager ASI16 inside a climate chamber. The System was connected by TCP/IP original standard cable and the original power supply. It was horizontally levelled inside the test chamber. The temperature is shown on the Measurement Chamber and also logged with the temperature sensor SHT85 of the internal data logger from ASI16.

Ort der Prüfung // Pace of certification:

CMS Ing. Dr. Schreder GmbH Lofererstraße 32, A-6322 Kirchbichl.

Umgebungsbedingung // Environment:

The Test was carried out under environmental conditions inside test chamber.

Kennzeichnung // Identification:

The system is identified by its serial number.

Messaufgabe // Task of measurement:

Temperature stress test. Test of functionality (1 image @ 5 minutes) during very hot environmental temperature scenarios ($\sim +75^{\circ}\text{C}$ up to about $+85^{\circ}\text{C}$) in standard working configuration.

Verwendete Messgeräte // Used instruments:

Climate Chamber Heraeus-Vötsch, VLK 04/150.

Sensirion RHT Sensor SHT85 (accuracy: $\pm 0.1^{\circ}\text{C}$ @ 20°C to $+50^{\circ}\text{C}$; $\pm 0.4^{\circ}\text{C}$ @ $+80^{\circ}\text{C}$; T_{ENV})

Infrared Thermometer TV325 (non-contact temperature measurement; accuracy $\pm 2^{\circ}\text{C}$; T_{TV325}).

Verwendete Unterlagen // Used documents:

- **Interne Arbeitsvorschrift:** carried out according to internal procedure, as applicable.

Bemerkung // Remark:

The documented results correspond exclusively to the stated instrument. A dependence of other influence parameters than the described one are not investigated.

MESSUNG/MEASUREMENT

Beschreibung/Description

The All Sky Imager (ASI) was put into the climate chamber. ASI was on standard operational mode (temperature regulation activated, 1 image @ 5 minutes) before starting the experiment. Measurements were made on automatic modus with standard exposure. The datalogger interval of ASI16 was set to 10sec. Measurements of the environmental air temperature T_{ENV} inside the climate chamber were carried out with the Sensirion RHT Sensor SHT85 of the ASI. Additional measurements of the air temperature inside the climate chamber were carried out with the infrared thermometer TV325.

The high temperature Test was started on day 20200704 and lasts over 12 days until 20200716. Tests are carried out with $T_{\text{ENV}} = +76^{\circ}\text{C}$ ($T_{\text{TV325}} = 77^{\circ}\text{C}$), $T_{\text{ENV}} = +82.5^{\circ}\text{C}$ ($T_{\text{TV325}} = 84^{\circ}\text{C}$) and $T_{\text{ENV}} = +85.5^{\circ}\text{C}$ ($T_{\text{TV325}} = 87^{\circ}\text{C}$). The temperature setting lasts for ~ 3 days @ 76°C , 3.5 days @ 82.5°C and ~ 6 days @ 85.5°C .



Temperature measurement:

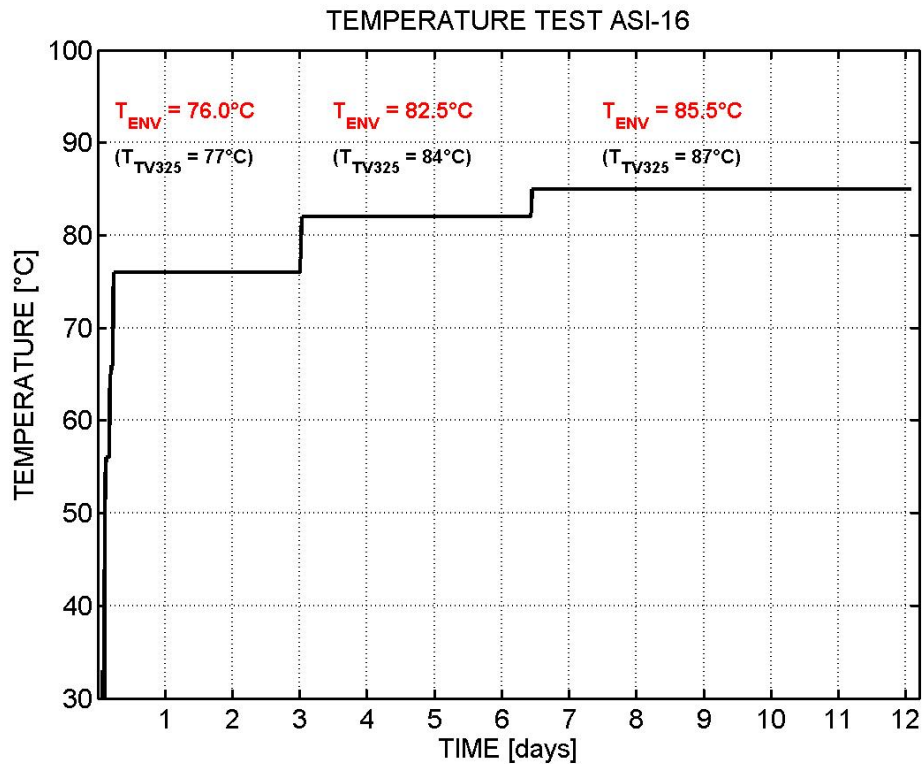

Web interface of the All Sky Imager:



CMS ASI-16 All Sky Imager

CMS Schreder - Tyrol Site #1 - Mete
 Office, Lofererstrasse 32, A-6322 Kirchbichl
 LAT: 47.49397 N - LON: 12.0922 E - ELE: 626m - [Open in google maps](#)

Home Imager System Help Language About

ASI 16015 2020/07/15 04:42:12

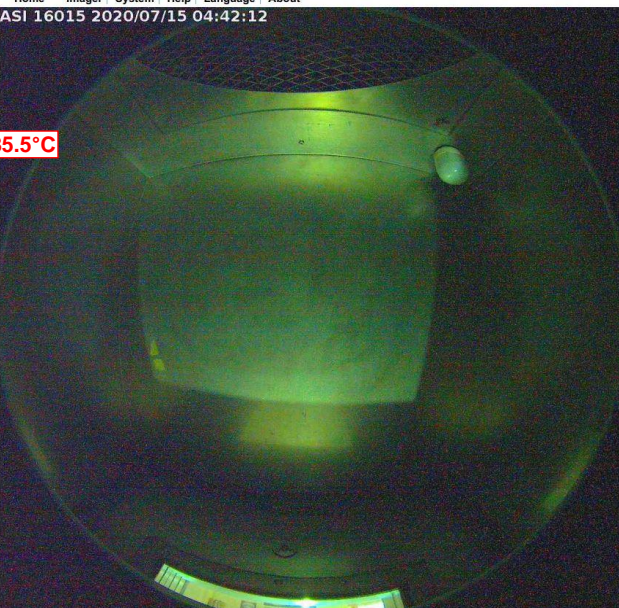

Live View Size

Auto 100% 50%

Capture JPG Image

All Sky Imager

ASI-16/50 Advanced V2015

Serial Number: 16015
 Ethernet MAC-ID: 0002D137803E
 Last Update: 2020-07-03
 Sky Imager SW: 2004160

Data Storage Status: online
 First JPG at/after: 00:15
 Last JPG before/at: 23:45

Peripherals

Connection status: online
 Hardware Version: MK03-1808
 Peripherals SW: 2001256

Fan Status: ON
 Heater Status: OFF
 Sensor Status: ON

Temperature: 85.5 °C
 Rel. Humidity: 0 %
 Dew Point: -28 °C

Pyranometer

Connection status: undefined
 CFG Type: 00 - Not Defined
 RSP Type: ---

Data sheet temperature sensor SHT85:

SENSIRION
THE SENSOR COMPANY

1 Humidity and Temperature Sensor Specifications

Relative Humidity

Parameter	Conditions	Value	Units
Accuracy tolerance ²	Typ.	±1.5	%RH
	Max.	see Figure 1	-
Repeatability ³	Low, typ.	0.21	%RH
	Medium, typ.	0.15	%RH
	High, typ.	0.08	%RH
Resolution	Typ.	0.01	%RH
Hysteresis	At 25°C	±0.8	%RH
Specified range ⁴	Non-condensing environment ⁵	0 to 100	%RH
Response time ⁶	τ 63%	8 ⁷	s
Long-term drift ⁸	Typ.	<0.25	%RH/y

Table 1: Humidity sensor specifications

Temperature

Parameter	Conditions	Value	Units
Accuracy tolerance ¹	Typ., 20°C to 50 °C	±0.1	°C
	Max.	see Figure 2	-
Repeatability ³	Low, typ.	0.15	°C
	Medium, typ.	0.08	°C
	High, typ.	0.04	°C
Resolution	Typ.	0.01	°C
Operating range	-	-40 to 105 ⁹	°C
Response time ¹⁰	τ 63%	>2	s
Long-term drift	Max.	<0.03	°C/y

Table 2: Temperature sensor specifications

² For definition of typ. and max. accuracy tolerance, please refer to the document "Sensirion Humidity Sensor Specification Statement".

³ The stated repeatability is 3 times the standard deviation (3σ) of multiple consecutive measurement values at constant conditions and is a measure for the noise on the physical sensor output.

⁴ Specified range refers to the range for which the humidity sensor specification is guaranteed.

⁵ Condensation shall be avoided because of risk of corrosion and leak currents on the PCB. For details about recommended humidity and temperature operating range, please refer to Section 1.2.

⁶ Time for achieving 63% of a humidity step function, valid at 25°C and 1 m/s airflow. Humidity response time in the application depends on the design-in of the sensor.

⁷ With activated ART function (see Section 4.8) the response time can be improved by a factor of 2.

⁸ Typical value for operation in normal RH/T operating range. Max. value is < 0.5 %RH/y. Value may be higher in environments with vaporized solvents, out-gassing tapes, adhesives, packaging materials, etc. For more details please refer to Handling Instructions.

⁹ All parts, incl. PCB are rated up to 125°C, except for the connector, which is rated for 105°C.

¹⁰ Temperature response time depends on heat conductivity of sensor substrate and design-in of sensor in application.

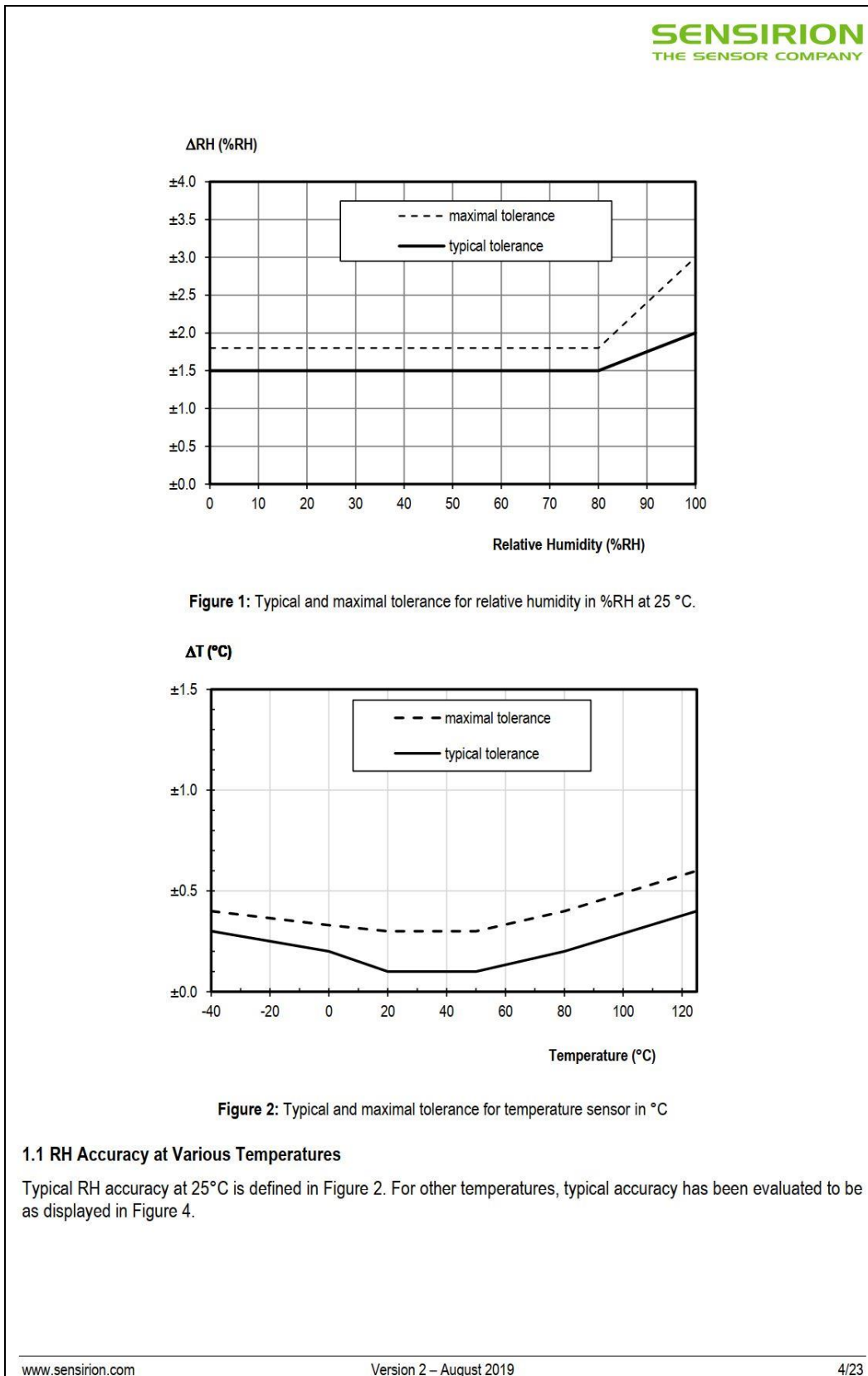

Prüfbericht Test Certificate

Prüfgegenstand // Object: Measurement of temperature behaviour of All Sky Imager ASI-16.

Auftraggeber // Customer: CMS Ing. Dr. Schreder GmbH
Lofererstraße 32, A-6322 Kirchbichl
AUSTRIA

Hersteller // Manufacturer: CMS Ing. Dr. Schreder GmbH

Typ // Type: ASI-16

Seriennummer // Serial number: 16015

Datum // Date: 13. June 2016 - 15. June 2016

Seitenanzahl // Number of pages: 3

Dieser Prüfschein darf nur vollständig und unverändert verbreitet werden. Auszüge oder Änderungen bedürfen der Genehmigung des Kalibrierlaboratoriums der Firma CMS Ing. Dr. Schreder GmbH. Dokumente ohne Unterschrift und Siegel haben keine Gültigkeit. // *This certificate shall not be reproduced other than in full extent with the permission of the calibration laboratory of the company CMS Ing. Dr. Schreder GmbH. Documents without signature and seal are not valid.*

Siegel // Seal

Ausstellungsdatum // Date

Für den technischen Inhalt verantwortlich
//Responsible regarding technical content

19. June 2016

Ing. Dr. Josef Schreder

Prüfgegenstand // Description of the calibration object:

Test of a All Sky imager ASI-16 inside climate chamber. The System was connected by TCP/IP standard cable and the original power supply. It was horizontally levelled inside the test chamber. The temperature is shown on the Measurement Chamber

Ort der Prüfung // Pace of certification:

CMS Ing. Dr. Schreder GmbH Lofererstraße 32, A-6322 Kirchbichl.

Umgebungsbedingung // Environment:

The Test was carried out under environmental conditions.

Kennzeichnung // Identification:

The system is identified by its serial number.

Messaufgabe // Task of measurement:

Measurement of temperature behaviour.

Verwendete Messgeräte // Used instruments:

Climate Chamber Heraeus-Vötsch, VLK 04/150
Infrared thermometer TV325.

Verwendete Unterlagen // Used documents:

- **Interne Arbeitsvorschrift:** carried out according to internal procedure, as applicable.

Bemerkung // Remark:

The documented results correspond exclusively to the stated instrument. A dependence of other influence parameters than the described one are not investigated.

MESSUNG/MEASUREMENT

Beschreibung/Description

The All Sky Imager (ASI) was put into the test chamber. ASI was on operational mode before starting cooling down the environment. Test cycles were started on day 20160613 at an environmental temperature T_{ENV} of +21°C. Lowest temperature of the test cycle was set to -40°C, highest temperature was set to +56°C. The device under test was running under operational modus (2 image @ 5 minutes) for about 45 hours.

Temperatures were logged with the ASI internal temperature sensor and an external temperature sensor (T_{EXT}). The T_{EXT} was put in a distance of about 8cm above the glass dome of the ASI. The T_{EXT} showed a temperature which was about +6 °C higher than the ASI temperature sensor. This temperature difference is the effect of the internal heating system of the ASI.

On day 20160613 the device under test was running under standard operation modus. Environmental temperature T_{ENV} was set at levels +21°C, +16°C, -10°C, -30°C, -40°C. The internal heating system of the device under test was running (electrical heating with about 60W). At 18:00 ($T_{ENV} = -30°C$) the heating system was switched off (not standard operation) to test the coldest environmental situation. ASI was running as required.

On day 20160614 the device under test was running under not standard operation modus (the internal heating system of the ASI was switched off). The internal heating system of the device under test was switched off. The T_{ENV} was set to -40°C since day 20160613. At 08:00 the power of the system was switched off to test the restart behaviour. After 4 hours at 12:00 power was switched on again. The ASI started and was working as required. At 16:15 the environmental temperature was set to +56°C. In

In addition the external ASI housing temperature was measured with an infrared thermometer (+56°C). ASI was running as required.

On day 20160615 the device under test was running under not standard operation modus (the internal heating system of the ASI was switched off). The environmental temperature was set to +56°C since day 20160615. ASI was running as required.

Ergebnis/Result

The All Sky Imager was successfully tested for standard operation modus under "Extended Temperature Range" between -40°C to +56°C, with a measurement and climate chamber control tolerance of ± 3 °C. Restart of the ASI was carried out with deactivated internal heating system at lowest environmental temperature. The system was running under all tested environmental situations without troubles. The temperature measurements are presented in the plots below.

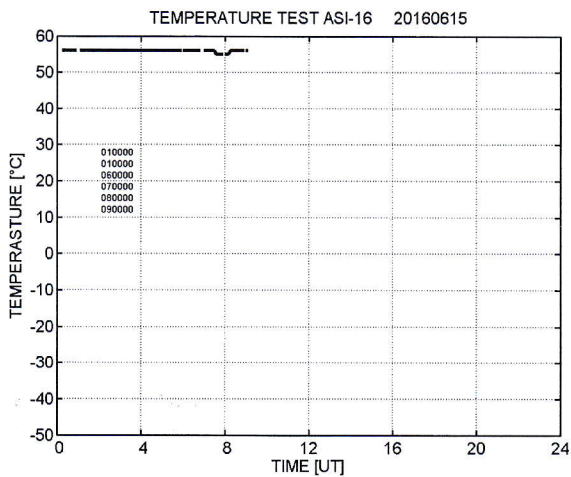
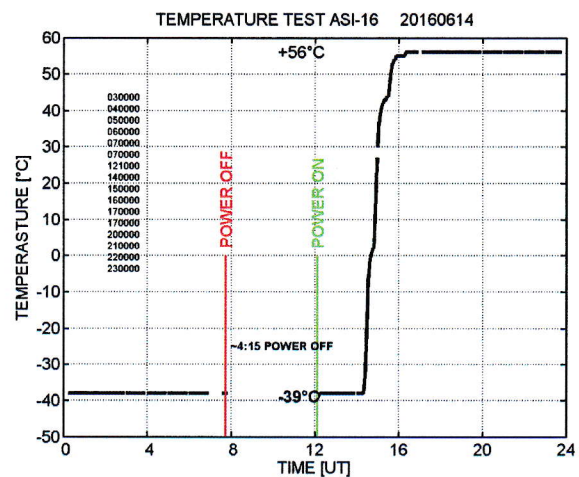
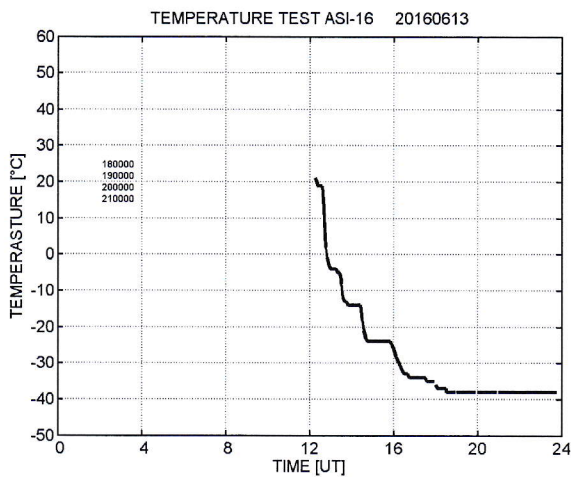

Prüfbericht Test Certificate

Prüfgegenstand // Object: Temperature stress test of All Sky Imager ASI-16.

Auftraggeber // Customer: CMS Ing. Dr. Schreder GmbH
Lofererstraße 32, A-6322 Kirchbichl
AUSTRIA

Hersteller // Manufacturer: CMS Ing. Dr. Schreder GmbH

Typ // Type: ASI-16

Seriennummer // Serial number: 16015

Datum // Date: 15. June 2016 - 19. June 2016

Seitenanzahl // Number of pages: 4

Dieser Prüfschein darf nur vollständig und unverändert verbreitet werden. Auszüge oder Änderungen bedürfen der Genehmigung des Kalibrierlaboratoriums der Firma CMS Ing. Dr. Schreder GmbH. Dokumente ohne Unterschrift und Siegel haben keine Gültigkeit. // *This certificate shall not be reproduced other than in full except with the permission of the calibration laboratory of the company CMS Ing. Dr. Schreder GmbH. Documents without signature and seal are not valid.*

Siegel // Seal

Ausstellungsdatum // Date

Für den technischen Inhalt verantwortlich
//Responsible regarding technical content

19. June 2016



Ing. Dr. Josef Schreder

Prüfgegenstand // Description of the calibration object:

Test of a Total Sky Camera ASI inside climate chamber. The System was connected by TCP/IP standard cable and the original power supply. It was horizontally levelled inside the test chamber. The temperature is shown on the Measurement Chamber

Ort der Prüfung // Place of certification:

CMS Ing. Dr. Schreder GmbH Lofererstraße 32, A-6322 Kirchbichl.

Umgebungsbedingung // Environment:

The Test was carried out under environmental conditions inside test chamber.

Kennzeichnung // Identification:

The system is identified by its serial number.

Messaufgabe // Task of measurement:

Temperature stress test. Test of functionality (2 images @ 5 minutes) during rapidly changing environmental temperature scenarios (<-30°C and >+45°C) in standard working configuration.

Verwendete Messgeräte // Used instruments:

Climate Chamber Heraeus-Vötsch, VLK 04/150

Verwendete Unterlagen // Used documents:

- **Interne Arbeitsvorschrift:** carried out according to internal procedure, as applicable.

Bemerkung // Remark:

The documented results correspond exclusively to the stated instrument. A dependence of other influence parameters than the described one are not investigated.

MESSUNG/MEASUREMENT

Beschreibung/Description

The All Sky Imager (ASI) was put into the test chamber. ASI was on standard operational mode (temperature regulation activated, 2 images @ 5 minutes) before starting the experiment. Measurements were made on automatic modus with standard exposure and under exposure.

Test cycles were started on day 20160615 and lasts over 4 days until 20160619. 10 stress cycles were carried out. Starting at an environmental temperature T_{ENV} of +56°C the temperature cycles were set to T_{ENV} lower -30°C and higher +45°C. The lowest T_{ENV} was -35°C. Additional the relative humidity inside the test chamber was logged. ASI was running as required.

Ergebnis/Result

The All Sky Imager was successfully tested for standard operation modus under "Temperature stress scenario" between $T_{ENV} = -35^{\circ}\text{C}$ and $T_{ENV} = +56^{\circ}\text{C}$, with a measurement and climate chamber control tolerance of $\pm 3^{\circ}\text{C}$. In total 10 stress cycles were carried out within 4 days. The system was running under all tested environmental situations without troubles – 2 images @ 5 minutes were taken without loss of image data. The temperature and humidity measurements are presented in the plots below.

